

WeMC3 Web-Enabled Master Clock



User's Manual

Rev.D



**National
Time & Signal**

28045 Oakland Oaks Ct.
(248)380-6264

Wixom, MI 48393
www.natsco.net

Table of Contents

- Introduction..... 2
- Wiring Connections 3
 - 120VAC Power 3
 - LAN Connection..... 4
 - Existing Time System Synchronization 5
 - Output Circuit Connections 6
 - Output Circuit Fuse 9
- Front Panel 10
 - Circuit Indicator LEDs 10
 - Status LED 10
 - Up/Right Buttons 10
 - Enter/Program Button 11
 - Exit Button..... 11
- Programming the WeMC3 12
 - Selecting Menus 12
 - Manual Control Menu: 12
 - Set Time and Date Menu: 12
 - Tech Menu: 13
 - Factory Menu: 13
 - Setting Time and Date 14
 - Tech Menu..... 16
- Manual Circuit Control 17
- Appendix A - Circuit Types..... 19
 - 00-Disabled 19
 - 01-Auxiliary..... 19
 - Manual Control of Auxiliary Circuits 19
 - 02-On Demand Instant Reset Clocks..... 20
 - Resetting On-Demand Instant Reset Clocks..... 20
 - 03-National EX Series Synchronous RESET 21
 - Resetting National EX Series Clocks..... 21
 - 04- National EX Series Synchronous RUN 22
 - Manual Control of EX Series (SRAX) Run Power 23
 - 07- RESET for Synchronous Clocks by others 23
 - Manual Control 23
 - 08- Synchronous Clocks by others..... 24
 - Manual Control 24
 - 09- Digital Clocks 24
 - Manual Control 24
- Appendix B - Clock Types 25
- Appendix C - Time Zones 27
- Appendix D - Synchronization Input..... 28
- Appendix E -Wiring Diagrams..... 29
- Appendix F - Specifications 33
- Appendix G - Mounting..... 34

Introduction

The WeMC3 Master Clock is a powerful master clock with the programming ease of a web interface. The WeMC3 comes standard with three solid state 120VAC outputs to directly control clock circuits or auxiliary outputs without the need for additional relays. These solid state outputs are capable of driving up to 3 amps each (7 amps combined) and incorporate zero-cross technology to handle undesirable current surges and inrush.

The WeMC3 provides PC browser based configuration and programming. Without requiring special software to be installed, the programming can be accomplished from any PC on the network with a standard web browser such as Internet Explorer or Firefox. Programming can even be done from a remote location to allow district or city-wide scheduling control.

The WeMC3 and secondary clocks combine to create a maintenance-free time system automatically synchronizing the clocks over the internet to the National Institute of Standards and Technology (NIST) for the most accurate time keeping. Alternately, a local network time server or any PC can be used to keep the clocks and auxiliary events perfectly synchronized with the computer network time. All clocks can be automatically adjusted for daylight savings adjustments and power outages. When there is a power loss, the WeMC3 can keep time internally for over 150 days without the need for batteries or expensive rechargeable battery packs.

The WeMC3 can correct the complete line of National Time & Signal clocks as well as clock systems by other manufacturers. The WeMC3 can even transmit National's On-demand Instant Reset to new clocks over the clock system wiring without affecting the existing clocks.

The WeMC3 can also synchronize time with a sound system, paging system, phone system, media retrieval system or an existing master clock which can provide a synchronizing output. This universal system synchronization is easy with an optically isolated input capable of receiving synchronization pulses of 17-132VAC from other sources. The synchronization pulses can be a simple contact closure at 12:00 or one of many common clock reset formats using National's Automatic Protocol Detection algorithm.

Wiring Connections

120VAC Power

The WeMC3 Master Clock is powered from a standard 120VAC 50 or 60 Hz power source. This connection supplies the power to run the WeMC3 as well as the clock circuit outputs. Refer to the Specifications section for power requirements.

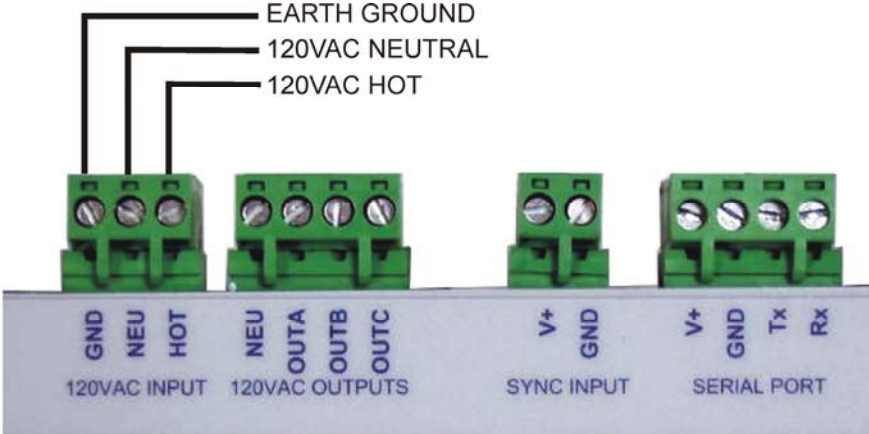

Figure 1: 120VAC Power Connections

LAN Connection

The LAN connection is located behind the serial port terminals as shown in the figure. A Standard RJ45 LAN patch cable is used to connect the WeMC3 to a network hub, router, or switch. During normal operation, the yellow LED on the connector will be on steady while the green LED will blink when there is network communication.

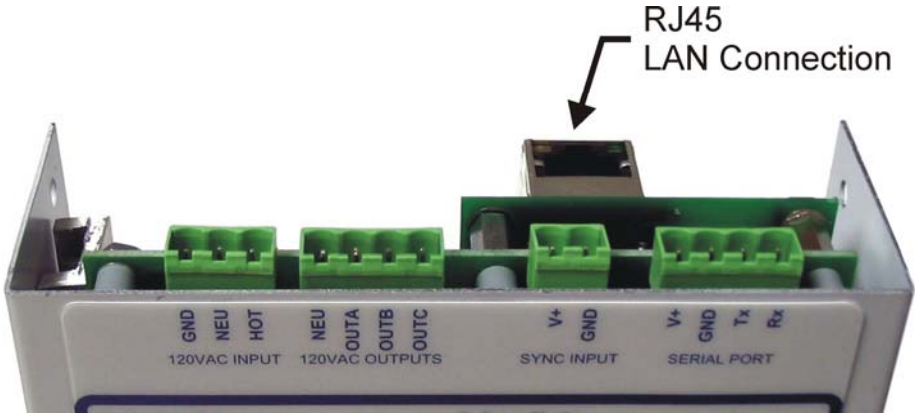

Figure 2: Network Cable Connection

Existing Time System Synchronization

The WeMC3 is capable of synchronizing the time with an existing clock or sound system. The optically isolated input can automatically decipher the clock reset protocol of other systems and automatically update the time display. This is a convenient way to achieve National's superior Instant Reset time protocol with existing systems. This connection is only required if it is necessary to synchronize the time of the WeMC3 with an existing system instead of using the LAN or internet NIST time base. A time server must remain undefined in the WeCAN™ browser interface to eliminate undesired time updates. Compatible formats include: National Time synchronous, Simplex synchronous, Faraday synchronous, Standard synchronous, and others or a simple 12:00 pulse. See Appendix D - Synchronization Input for details.

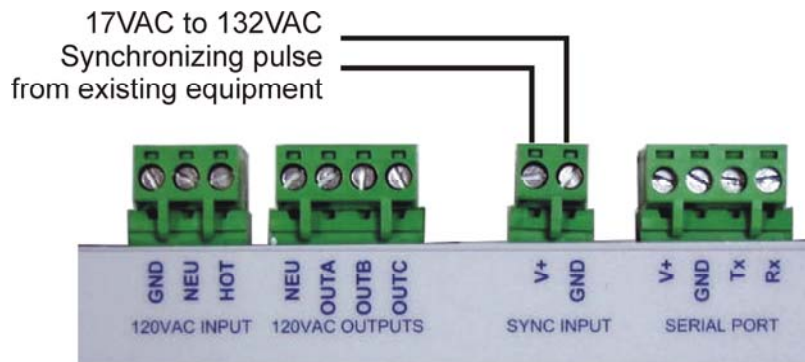

Figure 3: Synchronizing Input (Optional)

Output Circuit Connections

The WeMC3 outputs are solid-state 120VAC outputs with built-in surge and inrush protection using zero-cross sensing. Each output can drive 3 Amps of clocks or auxiliary devices up to a total of 7 Amps across all outputs. The connector includes an AC Neutral terminal to simplify wiring connections. For systems with only a 2-wire clock system such as National Time's RD2WS Series, there would be two circuits available for auxiliary devices.

The function of outputs A, B and C can be individually defined as either clock system power (RUN), clock system RESET, or an auxiliary output. Typically, for 3-wire synchronous clock types output A will control the motor (or RUN) power while output B controls the solenoid (or RESET) power. See Figure 4. The RUN output can power conventional synchronous clocks as well as transmit time data to On-Demand Instant Reset clocks sharing the same wiring.

For low voltage clock systems, the 120V outputs are used to control a 24VAC power transformer such as National's PS-3, PS-6 and PS-12 class 2 power-limited supplies.

Impulse clock systems would require external relays to control a DC power supply.

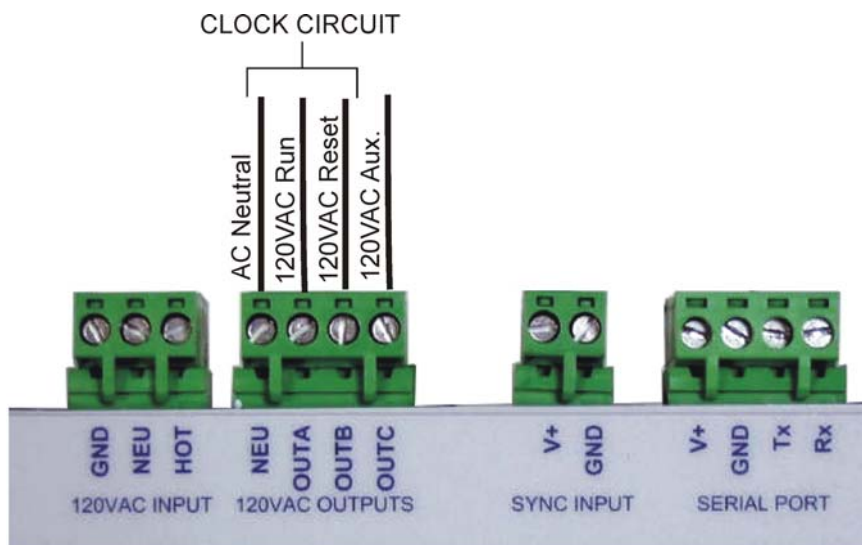

Figure 4: 3-Wire Clock Circuit Connections with RUN control

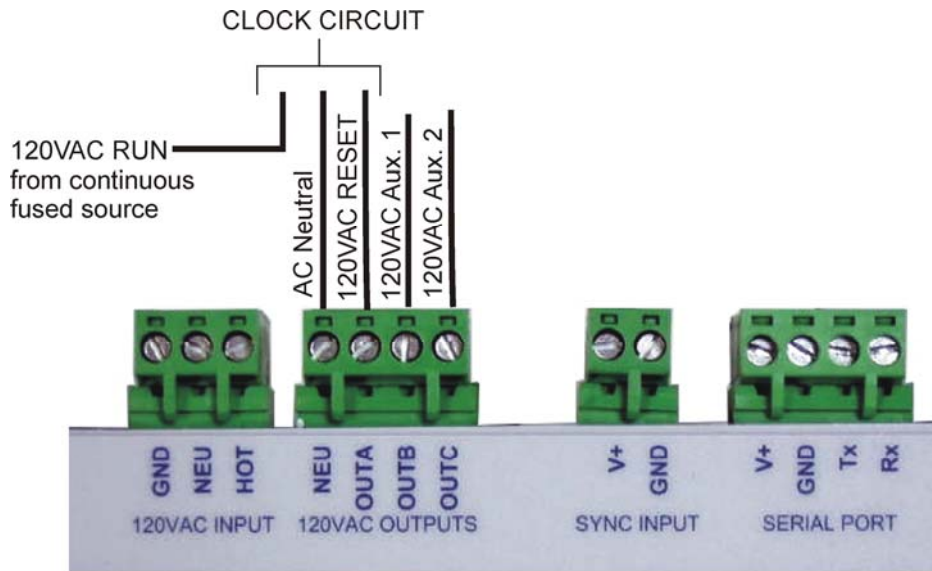

Figure 5: 3-Wire Clock Circuit without RUN control

For a 2-wire clock system such as National RD2WS or D/DX Series digitals, only output A is required. The clock power and time data information utilize the same wiring. TIP: Most synchronous clock systems only require the RESET of a 3-wire system to be controlled leaving two outputs for auxiliary programming. See Figure 5. Depending upon model, low voltage secondary clocks may require a PS-3/PS-6 power supply or a transformer at each clock (sold separately).

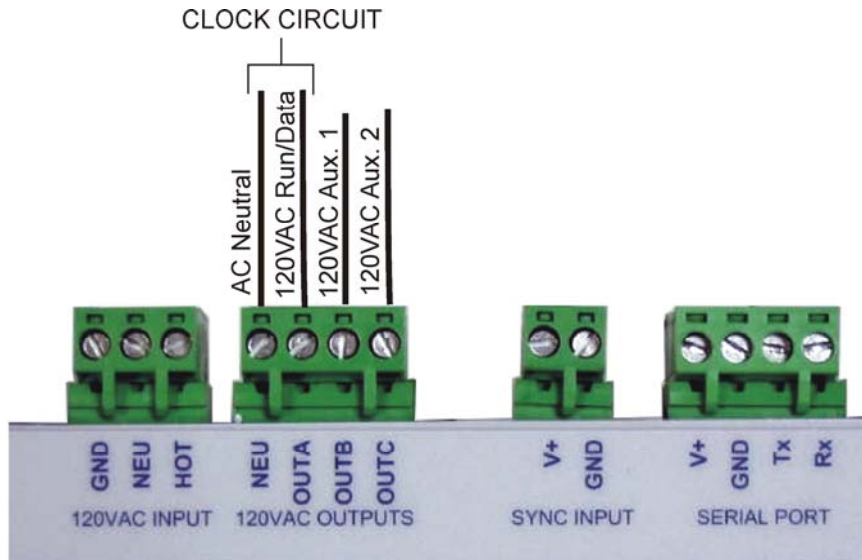

Figure 6: 2-Wire Clock Circuit and 2 Aux.

If there are no clocks in the system, the WeMC3 has all three outputs available for auxiliary event programming.

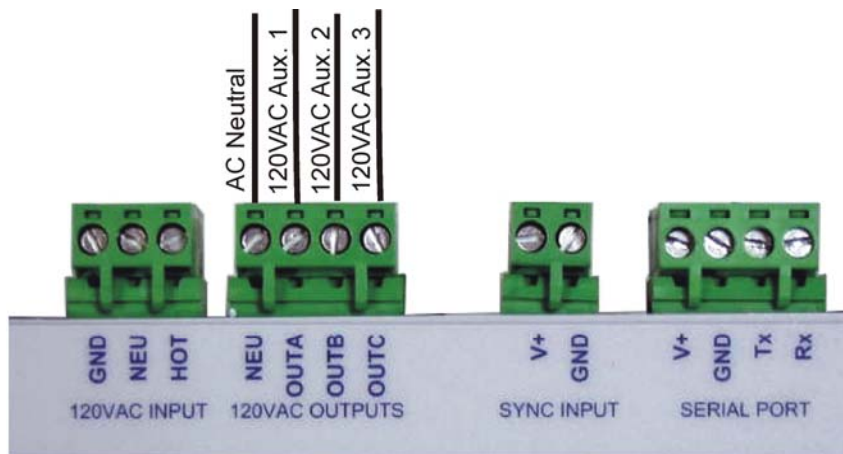

Figure 7: Three Auxiliary Outputs

Output Circuit Fuse

The three outputs of the WeMC3 are protected by a common fuse. If there is an over current condition on any of the three outputs, the fuse will blow causing all of the outputs to be disabled. The fuse is accessible by removing the WeMC3 main housing from the wall mounting plate. The fuse is located in the fuse holder shown in the figure. **Replace with a fuse of identical rating.** See Appendix F - Specifications. If desired, you may utilize an in-line fuse holder for each individual output.

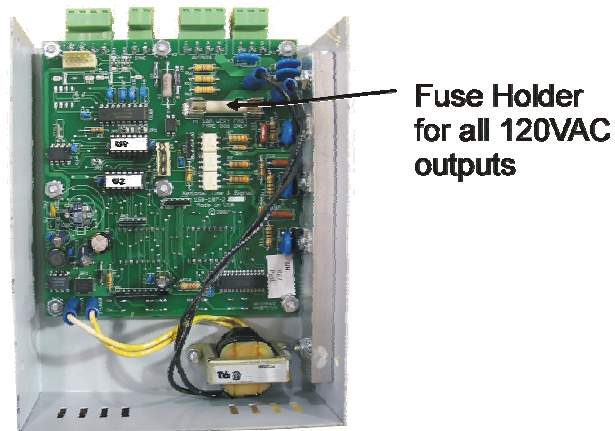

Figure 8: Output Fuse Location

Front Panel

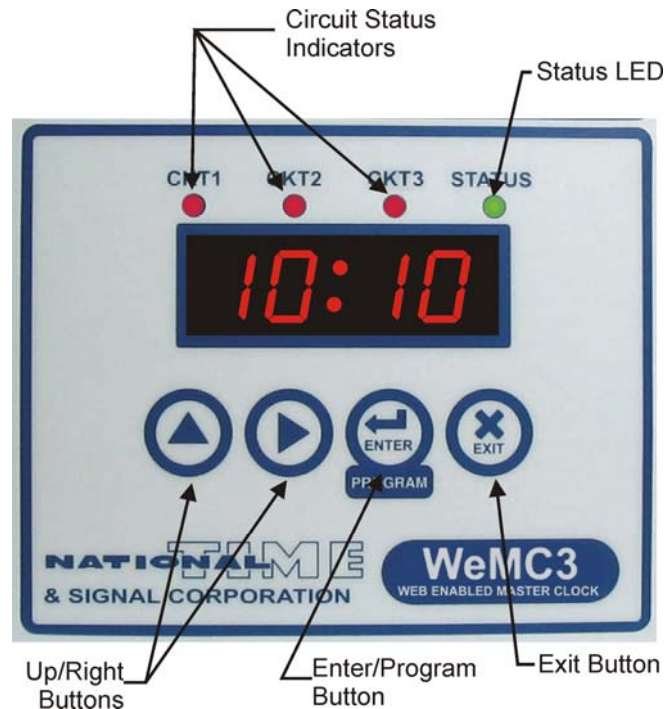

Figure 9: Front Panel

Circuit Indicator LEDs

The circuit indicator LEDs will reflect the status of the respective output. If the circuit is transmitting data or in the process of correcting a clock circuit, the LED will be blinking.

Status LED

The Status LED will indicate the status of the LAN time server.

On Steady: There is LAN or internet time server communication and time on the WeMC3 is synchronized.

Blinking: The LAN module is communicating with the WeMC3 but there is either no time information available or there is no connection to a network.

OFF: The WeMC3 is not configured to use a LAN interface or there is no communication with the LAN module. Check wire connections and that the LAN module is correctly mounted to the WeMC3 main board.

Up/Right Buttons

 These buttons are used to navigate through the setting menus and to select desired values. The UP arrow can also be used to enter the Manual Auxiliary Control Menu.

Enter/Program Button



This button is used to enter the various program menus of the WeMC3 as well as functioning as the Enter button for selecting appropriate values. The Program button will enter 4 levels of menus depending upon how long the button is held. See Programming the WeMC3 for details.

Exit Button



This button will return the WeMC3 to normal operation at any time. However, any values modified and followed with the Enter button will take effect.

Programming the WeMC3

Circuit and timekeeping settings can be accomplished either from the keypad of the WeMC3 or through the WeCAN™ web browser interface from a PC. All scheduling of auxiliary output events, however, must be programmed through the WeCAN™ web browser interface. Refer to the WeCAN™ Programming Manual bulletin C-475. The WeMC3 keypad can be used to manually correct the clock circuits as well as manually activate the auxiliary circuits for special events.

Programming of the WeMC3 through the keypad allows the circuit types and time to be programmed prior to the LAN connection. This often eases the initial commission of the system allowing the clock system wiring and operation to be verified prior to the hand off to the on-site IT department. The final steps of LAN time synchronization and auxiliary programming can then be completed at a later time.

Selecting Menus

The WeMC3 has 4 levels of menus that are accessed by pressing and holding the ENTER/PROGRAM button. The duration that the button is held determines which menu is activated. All menus must be accessed from the normal time display. If it is currently in a different menu, press EXIT first.

The menu structure is as follows:

Manual Control Menu:

Press PROGRAM once:



The Manual Control Menu is used to initiate a clock reset, turn off the clock circuit(s) or to activate an auxiliary output such as a bell or tone for special events. See the Manual Circuit Control section for details. These functions can also be accomplished through the WeCAN™ web interface.

Set Time and Date Menu:

Press and Hold PROGRAM for 5 seconds:



When pressed and held for at least 5 seconds, the set time/date menu is entered. See the Setting Time and Date section for details.

Tech Menu:

Press and Hold PROGRAM for 10 seconds:



When pressed and held for at least 10 seconds, the technician level programming menu is entered. This menu selects installation specific operating parameters of the WeMC3. See the technician level programming section.

Factory Menu:



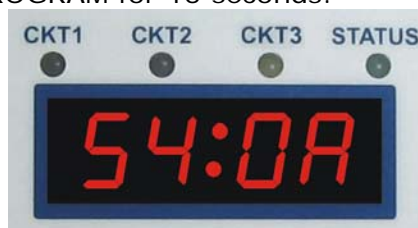











Press and Hold PROGRAM for 15 seconds:









Pressing and holding the button for 15 seconds will enter the factory menu. This menu allows alteration of the memory values to create custom clock reset protocols and are beyond the scope of this manual. Consult the factory for customization since changes to values in this menu may adversely affect clock operation.

Setting Time and Date

If the WeMC3 is setup to use a LAN time base, the time on the WeMC3 will be updated to the LAN time once an hour. An update to the LAN time can be manually initiated by selecting "Auto" when entering the hours. If a LAN time server is available, the time will be updated and the STATUS LED will turn on steady. See Status LED section for details.

		<p>From the normal time display, Press and hold the PROGRAM button.</p>
	<p>Hold 5sec.</p>	<p>The display will first enter the MANUAL CONTROL Menu; Keep holding until the display changes to the Set Time and Date Menu.</p>
	 	<p>Select the proper HOUR by pressing the UP arrow or keep incrementing until "Auto" is displayed to automatically set the time and date via the LAN interface. If the LAN is unavailable, the time may be entered manually, then will automatically update when it becomes available.</p> <p>Press Enter.</p>
	 	<p>Select the MINUTE by pressing the Up arrow.</p> <p>Press Enter when seconds are :00</p>
	 	<p>Select the MONTH by pressing the UP arrow.</p> <p>Press Enter.</p>
	 	<p>Select the DATE using the UP arrow.</p> <p>Press Enter.</p>

	 	<p>Select DAY of week using the UP arrow.</p> <p>1: Sunday 2: Monday 3: Tuesday 4: Wednesday 5: Thursday 6: Friday 7: Saturday</p> <p>Press Enter.</p>
	 	<p>Select the YEAR using the UP arrow.</p> <p>Press Enter.</p>

















Pressing the EXIT button at any time will return to the time display without continuing through all available settings.

Tech Menu

The technician menu is used to configure the output circuits and timekeeping functions of the WeMC3.

These functions would include:

- Circuit types for circuits 1, 2, and 3
- Daylight Savings (enable/disable)
- Time Zone selection













		<p>From the normal time display, Press and hold the PROGRAM button.</p>
	<p>Hold 5sec.</p>	<p>The display will first enter the MANUAL CONTROL Menu; Keep holding until the display changes to the Set Time and Date Menu.</p>
	<p>Hold 5sec. more</p>	<p>The display will enter the SET TIME and DATE MENU; Keep holding until the display changes to the TECH MENU.</p>
	 	<p>Select the Clock Type for Circuit 1. See Appendix A for details.</p> <p>Press ENTER.</p>
	 	<p>Select the Clock Type for Circuits 2 and 3. See Appendix A for details.</p> <p>Press ENTER.</p>
	 	<p>Enable or Disable DAYLIGHT SAVINGS adjustments by selecting 'E' or 'd' respectively.</p> <p>Press Enter.</p>
	 	<p>Select TIME ZONE using UP arrow. 05=-5 GMT (Eastern Time). See Appendix C.</p> <p>Press Enter.</p>

Manual Circuit Control

Manual circuit control is used to override the automatic operation of the WeMC3, activate auxiliary circuits, or to manually correct the clocks should they differ from the time as shown on the WeMC3.

The options available in the Manual Circuit Control Menu depend upon the circuit type selection. The menu selections and their functions for each circuit type are described in Appendix A - Circuit Types. *There is an alternative method to manually control the auxiliary outputs (bells, tones, etc.). Refer to the Auxiliary Circuit section of Appendix A - Circuit Types.*

To enter the Manual Circuit Control Menu:

		<p>From the normal time display, Press and release the PROGRAM button.</p>
	 	<p>Choose the desired circuit by pressing the UP arrow.</p> <p>When the desired circuit number is displayed, Press ENTER.</p>
		<p>The current ON or OFF status of the circuit is shown.</p> <p>Choose the desired function by pressing the UP arrow.</p>
		<p>The OFF selection will turn off the circuit and inhibit any automatic resets. If OFF is desired, press ENTER. Otherwise press UP arrow.</p>
		<p>The ON selection will turn ON the circuit and return the circuit to normal operation. IF ON is desired, press ENTER. Otherwise press UP arrow.</p>
		<p>This selection will allow manual activation of an auxiliary circuit (bells, tones, etc.).</p> <p>The output will activate as long as the ENTER button is held.</p>

		<p>The On-Demand Reset selection will turn the output ON and transmit time-data information to the RDS/D/DX clocks resetting them to the actual time. (Depends on circuit type selection.) If this is desired, press ENTER. Otherwise press UP arrow.</p>
		<p>The AUTO selection will allow an auxiliary circuit to be controlled by the schedule of the WeCAN™ software.</p>
		<p>The RESET selection will allow manual correction of the clock circuit. This will output a reset dependant upon clock type selection. (Not available for all clock types.)</p>
 	 	<p>The XX:XX menu will allow you to enter a time location for certain types of clock circuits. Press ENTER. The clocks will stop allowing you to note their location.</p> <p>Press the UP arrow to select the HOURS as shown on the secondary clock.</p> <p>Press RIGHT arrow.</p> <p>Press the UP arrow to select the MINUTES as shown on the secondary clock.</p> <p>Press RIGHT arrow.</p> <p>Press the UP arrow to select the SECONDS as shown on the secondary clock. (Does not apply for impulse type clocks)</p> <p>Press ENTER. The clocks will begin advancing to the correct time then return to NORMAL automatically.</p>

Appendix A - Circuit Types

The type for circuits 1 through 3 can be either configured through the keypad TECH menu or through the WeCAN™ programming interface. Any combination of clock types and auxiliary circuits may be selected. The following section describes the operation of the circuit types.

Circuit 1 controls Output A.

Circuit 2 controls Output B.

Circuit 3 controls Output C.

00-Disabled

When selected as disabled, the output will be OFF and no automatic resets or scheduled events will be transmitted.





01-Auxiliary







Used when it is desired to activate bells, chimes, tones etc. at scheduled times.

Manual Control of Auxiliary Circuits

The WeCAN™ web-browser user interface is used for event programming. The output can be activated manually at any time either through the WeCAN™ interface or through the keypad as follows:

To activate circuits programmed as auxiliary:

		<p>From the normal time display, Press and release the UP Arrow button.</p>
	 	<p>RING will be displayed and the circuit LEDs for each circuit programmed as an auxiliary output will blink.</p> <p>If it is desired to ring all auxiliary outputs, Press (and hold) ENTER for the desired duration.</p> <p>Or,</p> <p>If it is desired to ring an individual output, Press UP Arrow.</p>

	 	<p>The LED of the first circuit programmed as an auxiliary output will blink.</p> <p>If this is the desired circuit to activate, Press (and hold) ENTER for the required duration. Or, Press the UP Arrow to select the next circuit programmed as auxiliary.</p>
	 	<p>The LED of the next circuit programmed as an auxiliary output will blink.</p> <p>If this is the desired circuit to activate, Press (and hold) ENTER for the required duration. Or, Press the UP Arrow to select the next circuit programmed as auxiliary.</p>

02-On Demand Instant Reset Clocks



This selection will control National's Rotary Drive analog clocks (RD2WS/RD3WS Series) as well as National's digital clocks (D/DX/DU Series). Power to the clocks and time data share the same wires and provide instant resets to the exact time of day. This circuit is normally powered so that it may double as the RUN power for existing synchronous clocks and share the same wires.









Operation:

Will provide 'RUN' power to clocks and transmit Instant Reset time data upon power-up, during daylight savings correction and each 12:00am.

Resetting On-Demand Instant Reset Clocks

The On-Demand Instant Reset time data is automatically transmitted following power outages, daylight savings adjustments, and each midnight. If it is desirable to transmit the time data at other times or turn off power to the circuit, follow these steps:

	 	<p>From the normal time display, Press and release the PROGRAM button.</p>
---	--	--

	 Choose the desired Circuit by pressing the RIGHT Arrow button.  Press ENTER
   	 Press the UP Arrow until the desired action is displayed. On-D: This will transmit the On-Demand Instant Reset time data to all RDS/D/DX clocks correcting them to the exact time of day. It will then leave the circuit ON. On: Will turn on the power to the circuit. (On-demand clocks will advance to the 12:00 position.) OFF: Will turn off power to the circuit.  Then press ENTER. The clocks will reset to the time of day.

03-National EX Series Synchronous RESET



This selection will control the National EX Series (SRAX) synchronous clocks RESET output. The RUN output is individually controlled by a second output programmed as either Type 02 or Type 04.









Operation:

Will output 25 second hour reset pulse each xx:00:00. Will also output 25 minute 12-hour reset pulse each 6:00:00.

Resetting National EX Series Clocks

Reset cycles can be initiated through the WeCAN™ interface from any PC or through the keypad of the WeMC3 as follows:

	 From the normal time display, Press and release the PROGRAM button.
---	--

	 Choose the Circuit defined as EX Series Reset (type 03) by pressing the RIGHT Arrow button. (Usually, Circuit 2 is used for this purpose.)  Press ENTER
   	 The current state of the circuit is displayed. Press the UP Arrow until the desired action is displayed. <p>RST: This will activate an Hour reset by turning on for 25 seconds. The clocks will immediately advance to the next hour. (This will not set the clocks to the correct time. This would be used to advance all of the clocks by one hour.)</p> <p>Auto: Will allow automatic resets to be output to the clocks.</p> <p>OFF: Will inhibit resets from being output. (To turn off power to the clocks, the circuit controlling the RUN power is set to OFF.)</p>  Then press ENTER. The clocks will reset to the time of day.

04- National EX Series Synchronous RUN









This clock type is used to provide power to a National EX (SRAX) series clock circuit. This circuit will also provide "drift compensation" to ensure clocks are kept on time as well as daylight savings correction in the fall. If it is desirable to share the circuit with On-Demand clocks, set the RUN output to Type 02 instead.

Operation:

The output will be energized whenever the clock is in the NORMAL timekeeping mode. Drift compensation will turn off the circuit for 1 second each xx:59:00 to keep the clocks behind real time. Daylight savings in the fall will turn off the output for 1 hour at 2am.

Manual Control of EX Series (SRAX) Run Power

To manually turn off power to the SRAX clock circuit and stop all of the clocks, do the following:

		<p>From the normal time display, Press and release the PROGRAM button.</p>
	 	<p>Choose the Circuit defined as EX Series Run (type 04) by pressing the RIGHT Arrow button. (Usually, Circuit 1 is used for this purpose.)</p> <p>Press ENTER</p>
 	 	<p>The current state of the circuit is displayed.</p> <p>Press the UP Arrow until the desired action is displayed.</p> <p>On: Power is applied to the output (normal).</p> <p>OFF: Will turn off power to the clocks.</p> <p>Then press ENTER.</p>

07- RESET for Synchronous Clocks by others

This selection will control synchronous clocks common to other manufacturers. Refer to Appendix B - Clock Types for specific models. The circuit programmed as this type will output the reset sequences required for the clocks. The RUN power can either be directly wired to the required power source, or share the power/data output of a Type 02 circuit of On-Demand clocks. Refer to the wiring diagram section for details.

Operation:

Will output an 8 second hour reset pulse each xx:57:54 and a 14 second 12-hour reset pulse each 5:57:54.

Manual Control

The circuit programmed for this type can be manually controlled either to OFF (to inhibit all automatic pulses) or to AUTO (normal). The menu is similar to the Type 03 clock type.

08- Synchronous Clocks by others

This selection will control synchronous clocks common to other manufacturers. Refer to Appendix B - Clock Types for specific models.

Operation:

Will output a 55 second hour reset pulse each xx:58:05. This circuit will also output 95 second 12-hour reset pulses every other minute between 5:05:00 and 5:21:00.

Manual Control

The circuit programmed for this type can be manually controlled either to OFF (to inhibit all automatic pulses) or to AUTO (normal). The menu is similar to the Type 03 clock type.

09- Digital Clocks

This selection will control digital clocks common to other manufacturers. Refer to Appendix B - Clock Types for specific models.

For National Time D/DX/DU Series digital clocks, refer to Type 02 - On Demand Instant Reset Clocks.

Operation:

This circuit will provide 'RUN' power to clocks.

Each 12:00 midnight, power will be removed for 2 seconds causing clocks to reset to 12:00.

Manual Control

This circuit can be manually turned OFF (which will remove power and inhibit resets) or to AUTO (normal). The manual control menu is similar to the TYPE 02 clock type.

Note - If it is desirable to have an output that is normally OFF and pulses ON for 2 seconds at midnight, the circuit can be programmed as an auxiliary circuit and controlled by a scheduled event using the WeCAN™ browser interface.

Appendix B - Clock Types

	Circuit No.	Voltage	Type Code	Wiring Fig.
Secondary Clock Type				
National Time RD2WS, D/DX Digital	1-3	120	02	1
National Time RD2WS, D/ DX Digital	1-3	24	02	2
National Time EX (SRAX) Sync. RESET	2	120	03	3,4
National Time EX (SRAX) Sync. RUN	1	120	04	3
National Time EX (SRAX) Sync. RESET	2	24	03	5,6
National Time EX (SRAX) Sync. RUN	1	24	04	5
Combination EX and RD2WS, D/DX	1,2	120	02	7
Combination EX and RD2WS, D/DX	1,2	24	02	8
National Time 2MR Available on MC3 Only				
National Time 3MR,HMR,4MR etc. Available on MC3 Only				
National Time 120V Resetting Minute Impulse (3MIR, HMIR, 4MIR, 7MIR etc.) Available on MC3 Only				
Simplex 2310-92XX,57, 77,93-9,91-9,941-9,943-9 Series	1-3	120	07	4
IBM 57,62,67,77,82 and 87 Series	1-3	120	07	4
Cincinnati D10 and D12	1-3	120	07	4
Lathem SS12 Types	1-3	120	07	4
Edwards 010 Synchronous, 2400 Series	1-3	120	07	4
Rauland 2460 Series	1-3	120	03	4
Rauland 2460 Series Low Voltage	1-3	24	03	6
Dukane 24030, 24023, 24050, 24060,24010	1-3	120	03	4
Dukane 24030, 24023, 24050, 24060,24010 Lv	1-3	24	03	6
Honeywell St402,403,404,410-413,802-804,810-813	1-3	120	08	4
Faraday 1310,1311,1320,1321	1-3	120	08	4
Cincinnati D8	1-3	120	08	4
Standard/Faraday New Types 2310, 2331	1-3	120	08	4
Standard Electric Time 2370, 2380 Series	1-3	120	07	4
ATS CC2000 Series Digital System Clocks	1-3	120	07	4
Stromberg 3000	1-3	120	07	4
American A4015D10	1-3	120	07	4
Combine National RDS/D/DX with any	1,2	120	02,xx	7

	Circuit No.	Voltage	Type Code	Wiring Fig.
Secondary Clock Type				
conventional synchronous on same wires. Ckt1 as type 02, Ckt2 as 07,08 etc.				
Generic Digital Clock	1-3	120	09	1,2

Appendix C - Time Zones

When using the NIST time bases such as a LAN time server, NIST website, or a GPS antenna, the WeMC3 uses the Universal Coordinated Time (UTC) standard (formerly known as Greenwich Mean Time). To acquire the local time in your area, this time must be adjusted based upon the time zone. The time zone number may be designated either through the WeCAN™ interface or through the WeMC3 Tech Menu.

Zone Number	Description
00	UTC (Universal Coordinated Time)
01	UTC -1:00
02	UTC -2:00
03	UTC -3:00
04	UTC -4:00
05	UTC -5:00 (U.S. Eastern Time)
06	UTC -6:00 (U.S. Central Time)
07	UTC -7:00 (U.S. Mountain Time)
08	UTC -8:00 (U.S. Pacific Time)
09	UTC -9:00 (Alaska)
10	UTC -10:00 (Hawaii)
11	UTC -11:00
12	UTC -12:00
13	UTC +1:00
14	UTC +2:00
15	UTC +3:00
16	UTC +4:00
17	UTC +5:00
18	UTC +6:00
19	UTC +7:00
20	UTC +8:00
21	UTC +9:00
22	UTC +10:00
23	UTC +11:00
24	UTC +12:00
25	UTC +13:00
26	UTC -3:30 (Newfoundland)

Appendix D - Synchronization Input

The synchronization input will automatically adjust the time of the WeMC3 to match an existing system. The input is wired to the existing system as if it were a secondary clock correction coil. Since many protocols do not identify am or pm, it is wise to disable the daylight savings adjustments of the WeMC3 and allow the time source master to make the adjustments. See Tech Menu for selection directions. The LAN/WAN time server must be disabled through the WeCAN™ browser interface. Otherwise, the time will be adjusted by both the SYNC INPUT and the LAN time server with undesirable results.

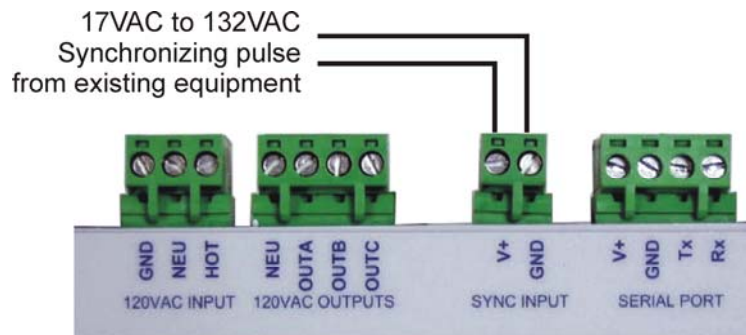

Figure 10

The protocol will automatically be deciphered from the following protocols:

Format 1: 25 second pulse each hour at xx:00:00. 25 minute pulse each 6:00:00.

Format 2: 8 second pulse each hour at xx:57:54. 14 second pulse each 5:57:54.

Format 3: 2 second pulse each 12:00 am and/or pm.

Format 4: 55 second pulse each xx:58:05. 95 second pulse every other minute starting at 5:05:00 and ending 5:22:00. Variations of the 12 hour pulses are allowed. Any pulse 55 seconds to 100 seconds any minute between 4:59 and 5:40.

Format 5: On-Demand Instant Reset time data from another National Time master or URT.

Appendix E -Wiring Diagrams

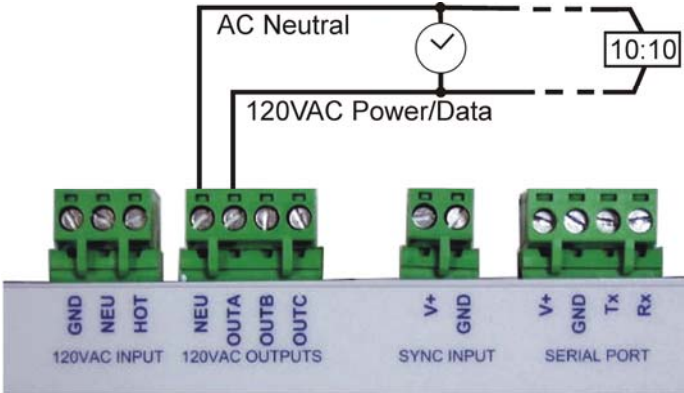

Wiring Figure 1: Two-wire clocks 120V

(Clocks may require appropriate transformer for 120V operation)
 For Circuits 2 or 3, substitute OUTB and OUTC for OUTA respectively.

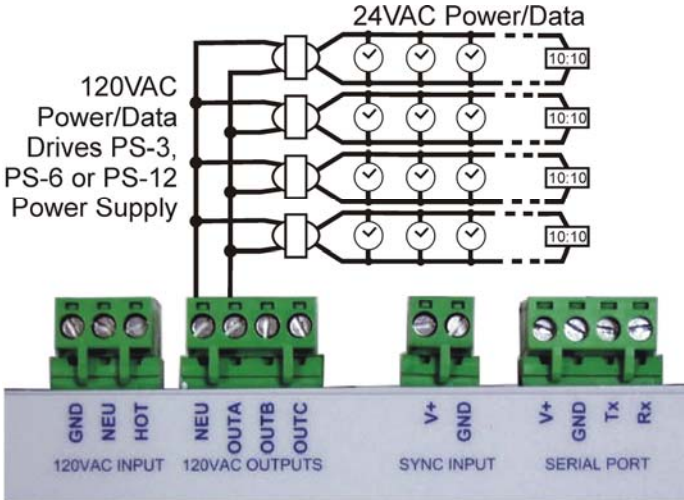

Wiring Figure 2: Circuit 1 two-wire clocks 24V

For Circuits 2 or 3, substitute OUTB and OUTC for OUTA respectively.

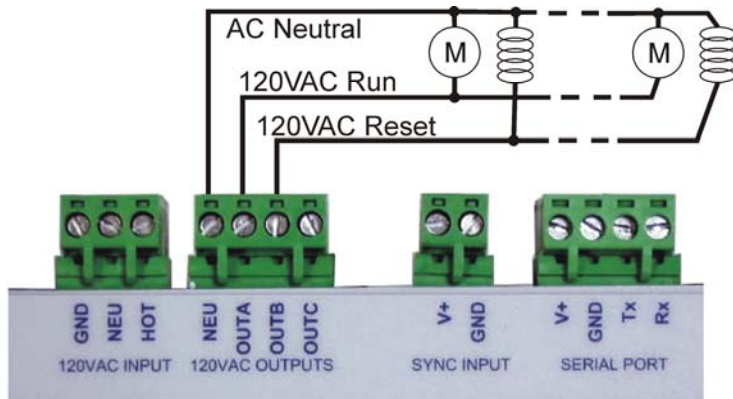

Wiring Figure 3: Three-wire synchronous clocks

For EX Series clocks, Circuit 1 is programmed as TYPE 04 RUN power, Circuit 2 is programmed as Type 03 RESET.

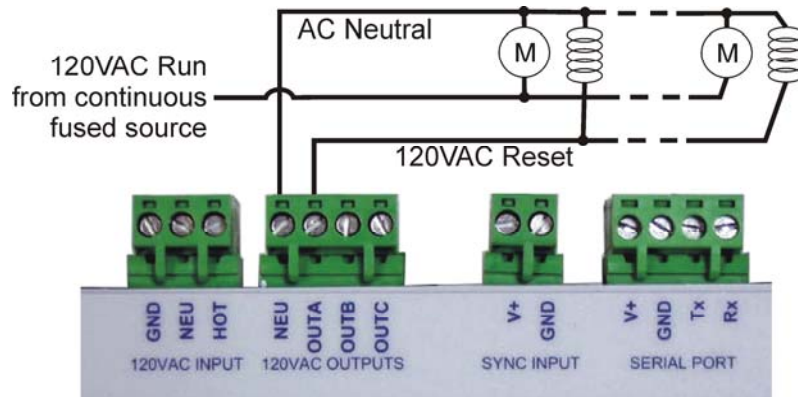

Wiring Figure 4: Three-wire synchronous clocks

Run power is not controlled. For Circuits 2 and 3, substitute OUTB and OUTC for OUTA respectively.

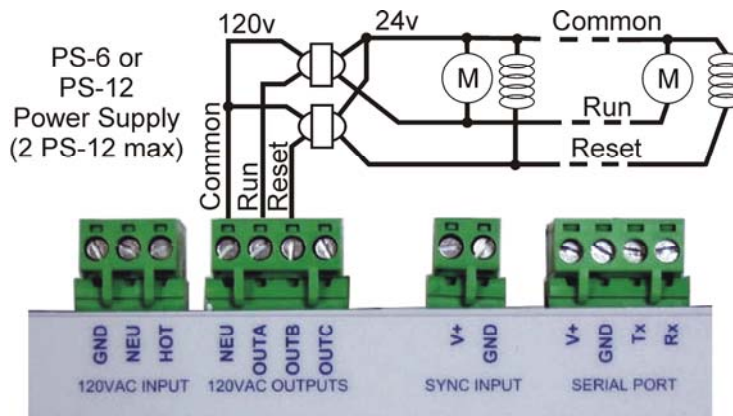

Wiring Figure 5: Three-wire sync. clocks 24v

For EX Series, Circuit 1 is programmed as TYPE 04 and Circuit 2 is programmed as TYPE 03.

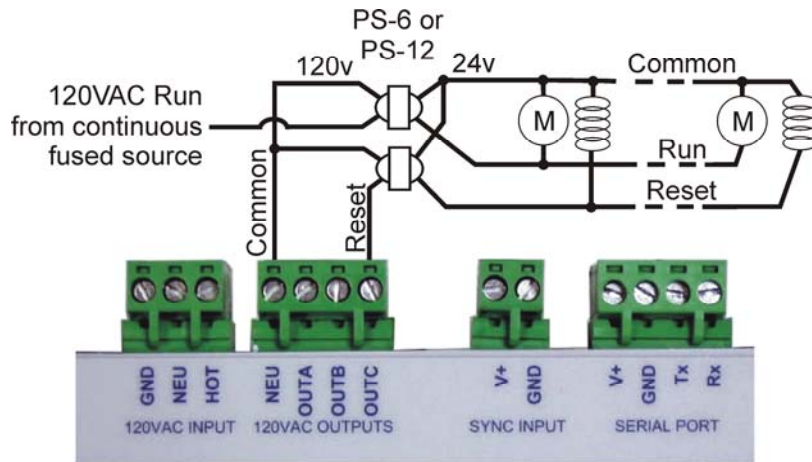

Wiring Figure 6: Three-wire sync. Clocks 24v
 Run power is not controlled. For Circuits 1 and 2, substitute OUTA and OUTB for OUTC respectively.

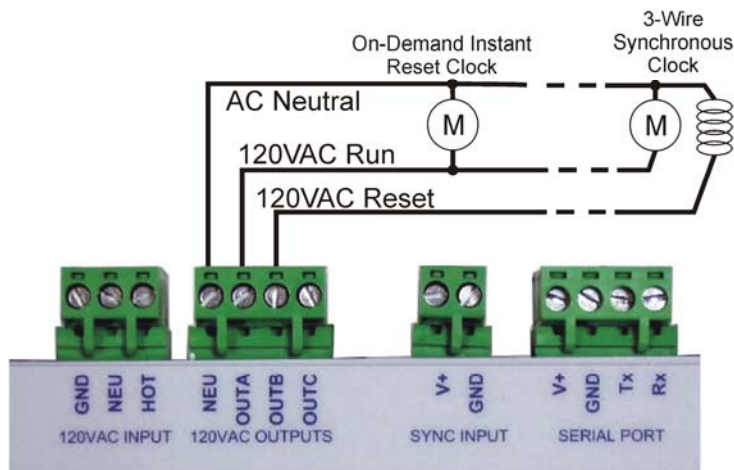

Wiring Figure 7: On-Demand and Synchronous Combination 120V

(On-Demand clocks may require appropriate transformer) Circuit 1 is programmed as TYPE 02 On-Demand clocks and Circuit 2 is programmed as a Synchronous Clock RESET such as TYPE 03.

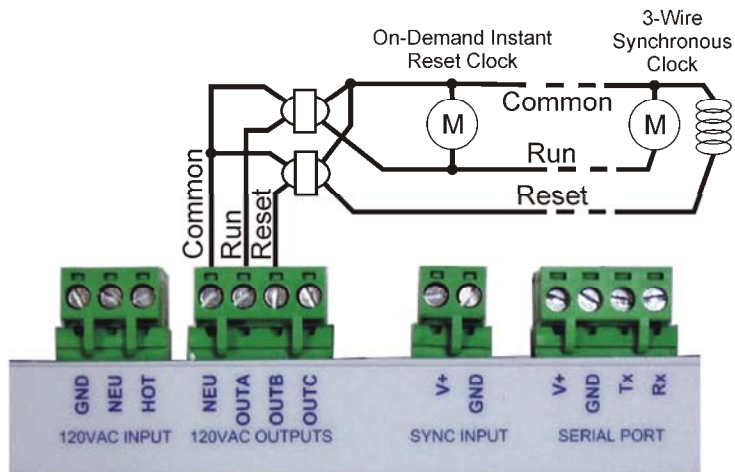

**Wiring Figure 8: On-Demand and Synchronous Combination
24V**

Circuit 1 is programmed as TYPE 02 On-Demand clocks and Circuit 2 is programmed as a Synchronous Clock RESET such as TYPE 03.

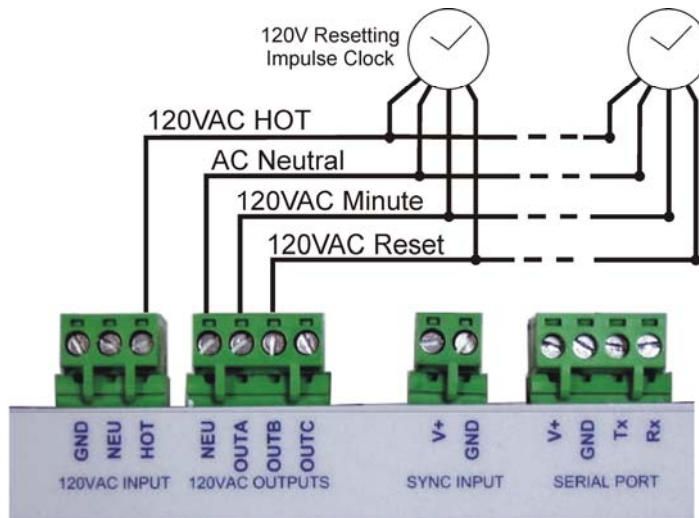

Wiring Figure 9: 120V Resetting Impulse Clock

Appendix F - Specifications

Primary Voltage:	120VAC @ 60Hz or 50Hz
Primary Current:	
Full Load (max. devices)=	7.025A @ 120VAC/60Hz
No Load (no devices) =	0.025A @ 120VAC/60Hz
Typical Load=	0.025A+Ckt Load @120VAC/60Hz
Sync. Input Voltage:	17 to 132VAC
Sync. Input Current:	22mA @ 120VAC; 3mA @ 24VAC
Primary Fuse:	10A 250VAC Very Fast type GBB
Circuit Output Rating:	
Per circuit=	3A @ 120VAC
3 circuit total=	not to exceed 7A@120VAC combined
Serial Port 24VDC:	100mA @ 24VDC Nominal
RS232 wiring distance:	
WeMC3-GPS=	30 Ft. (Standard)
WeMC3-GPS=	100 Ft. using shielded Low capacitance cable
LAN Connector:	RJ45
Ambient Temp. Range:	32 to 104 Degrees Fahrenheit Indoor Use Only
Humidity:	85% Non-condensing max.
Mounting:	
Semi-Flush Mount=	Mounts to a flush mounted 4" Square, Double-Gang, Handy box or Single-Gang
Surface Mount=	Mounts to wall with surface Conduit entry
Conduit Entry:	
Semi-Flush=	Conduit enters flush mounted Standard Electrical boxes
Surface Mount=	3 Knockouts @ ½", top entry
Dimensions:	5.5"W x 9.75" H x 2.38"D

Appendix G - Mounting

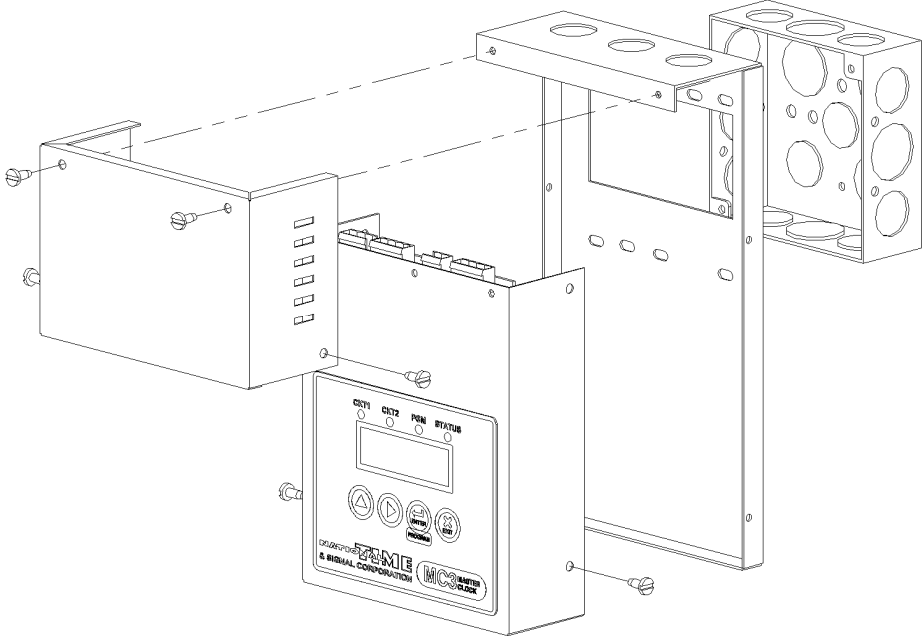

Figure 11: Semi-Flush Assembly

